



Ginger

Joan Gaspar

marset



Ginger 60C

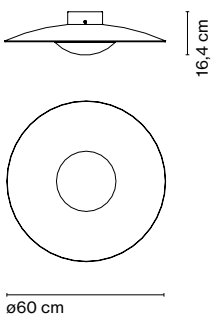

Ginger 42C

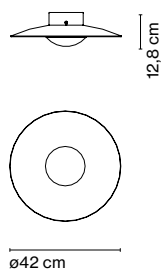

Ginger 32C

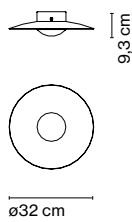

Accessory C2

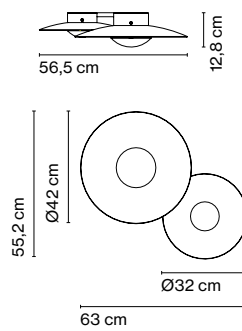

Accessory C3

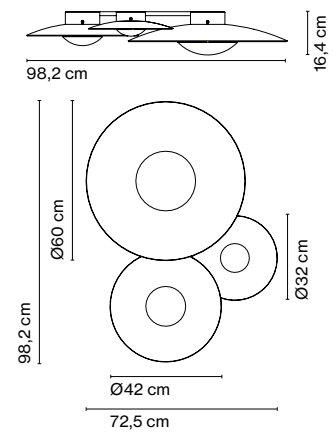

Ginger 32C

LED SMD 11,5W 700mA 2700K CRI90
Light source 1019lm
Luminaire 350lm
(included)

Pressed wood diffuser of 4mm in natural oak or wenge. Injected and lacquered black metal matte aluminium dissipater.

- Oak - Oak
- Wenge - Wenge
- Oak - White
- Wenge - White

Ginger 42C

LED SMD 21,7W 700mA 2700K CRI90
Light source 2039lm
Luminaire 698lm
(included)

- [Download](#) Assembly Instructions
- [Download](#) Energy label
- [Download](#) 2D
- [Download](#) 3D
- [Download](#) Photometric Data

Ginger 60C

LED SMD 28,5W 700mA 2700K CRI90
Light source 3048lm
Luminaire 1165lm
(included)



Watch the video
info@marset.com
www.marset.com

Accessory C2

LED SMD 33,2W 700mA 2700K CRI90
Light source 3058lm
Luminaire 1048lm
(included)

Accessory C3

LED SMD 61,7W 700mA 2700K CRI90
Light source 6106lm
Luminaire 2213lm
(included)

Range

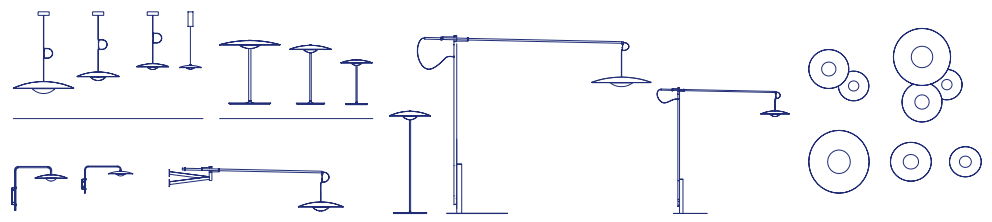

These ceiling lamps, which are formally extremely simple, are manufactured in three sizes. They also come in a set of two or three pieces to meet the qualities and needs of the space.

How Ginger illuminates

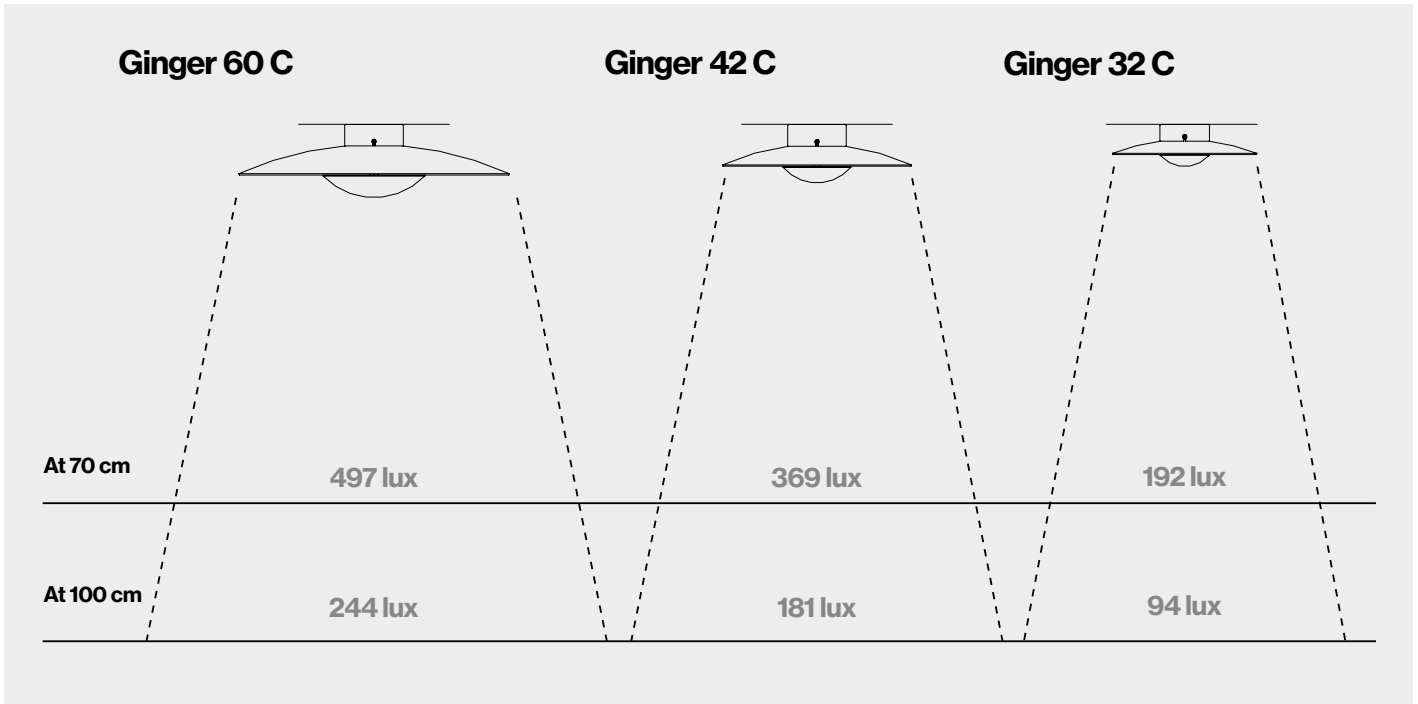

Accessory C2

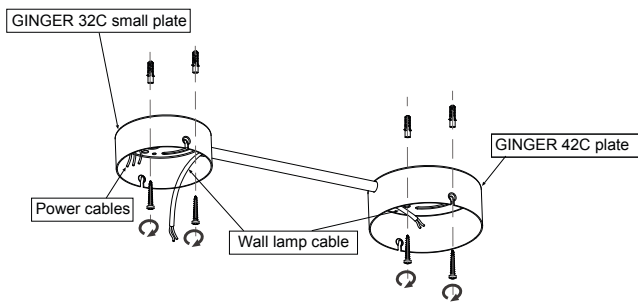
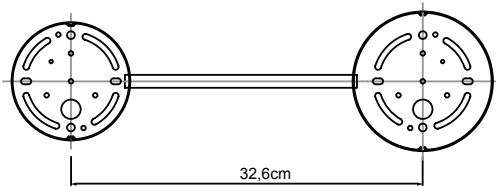

Accessory C3

